

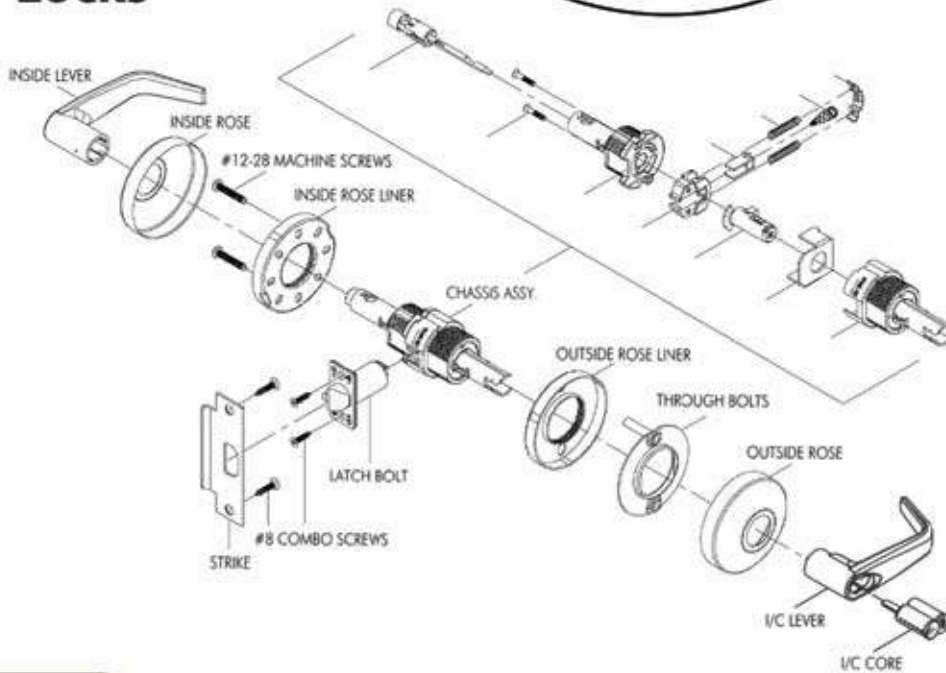

MB1A Grade 1 SFIC Cylindricals

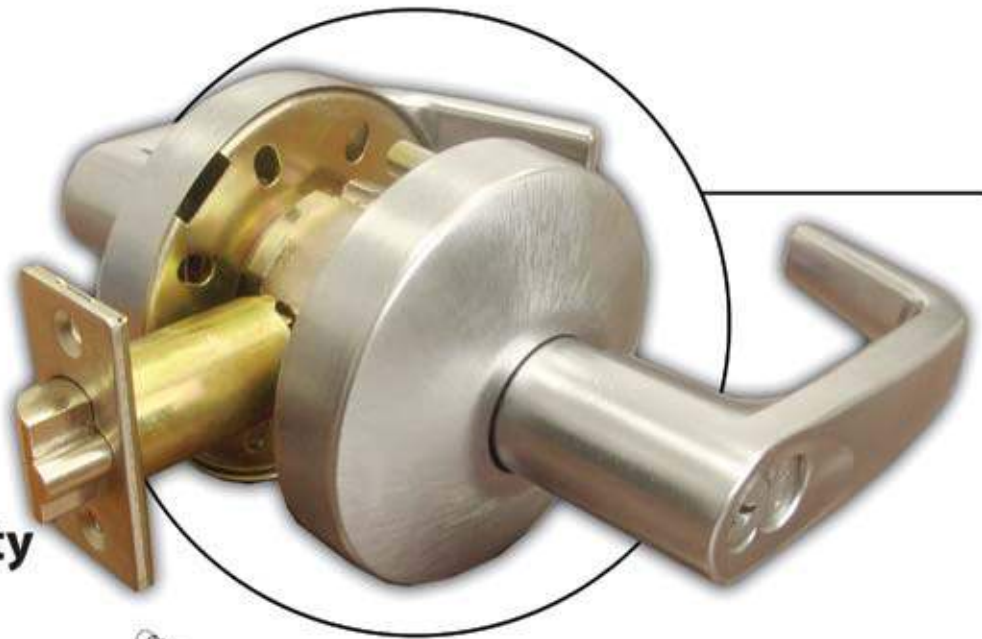

MB1A Series ANSI Grade 1 Extra Heavy Duty Lever Locks



FEATURES:

- Heavy duty chassis, through bolt trim with various lever styles available.
- Strong cast and machined stainless steel hubs.
- Heavy duty return springs provide resistance to lever sag.
- Tested to over 4,000,000 cycles which exceeds the ANSI standard for Grade 1 cylindrical locks.
- Heavier rose liner material provides greater attack resistance.
- Heat treated, heavy gauge cold rolled steel allows 1000 inch-pounds of torque to be applied to the locked lever without allowing access.
- Threaded inside and outside rose assembly adjustable for door thickness without removing keyed lever.
- Exceeds Grade 1 abusive locked lever torque.

MB1A Series Lever Locks

SPECIFICATIONS:

- Door Thickness** - 1-3/8" to 2" wood or metal door standard, 2-1/4" is available.
- Backset** - 2-3/4" standard; 2-3/8", 3-3/4" and 5" optional.
- Latchbolt** - 1/2" throw deadlatch, UL listed, self-adjusting faceplate; 3/4" throw fire door deadlatch available.
- Handing** - Non-handed.
- Strike** - S1 ANSI strike standard, S2 T strike optional.
- Lever Handles** - Solid zinc diecast levers, wrought brass roses, concealed screws. I/C core version standard.
- Door Preparation** - ANSI A115.2, through bolt installation.
- Interchangeable Core (Standard)** - 6 or 7 pin with nickel silver keys, compatible with Best® and Falcon® cores.
- Masterkeyed** - Can be masterkeyed or grand masterkeyed and construction key systems available.
- Finishes** - 605, 606, 612, 613, 625 and 626.
- Certifications** - UL listed for "A" label (3 hour) single swinging door (4'x8'). ETL certified for ANSI/BHMA A156.2, Series 4000 Grade 1.
- Warranty** - SEVEN (7) YEAR manufacturer's limited warranty.

Lever Handles



Cylinders



Latches



Strikes

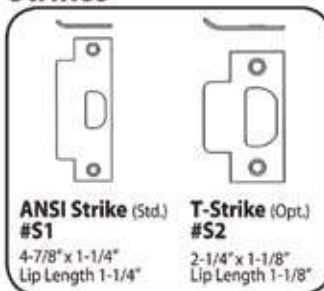

Extension Links

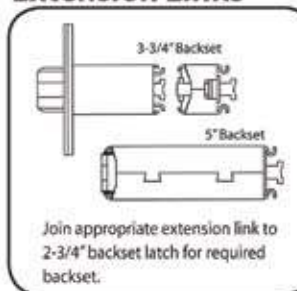

Certifications - UL Listed:
 Listed by Underwriter's Laboratories
 for use on 1 1/8\"/>

ANSI
 American National Standard: ANSI A156.2, Series 4000 Grade 1
 (Formerly IT-41-106C Series 161)

BHMA
 CERTIFIED
 The Best in Door Locks for the World

Finish	BHMA	US	Description
600	2	2	bright brass
606	4	4	satn brass
612	10	10	satn bronze
613	108	108	oxidized satn bronze, oil rubbed
625	26	26	bright chromium plated
626	26D	26D	satn chromium plated
629	US32	US32	bright stainless steel
630	US32D	US32D	satn stainless steel

How To Order	Model Series	Backset	Function Code	Lever Handle	Finish	Strike	Options
	MB1A	3	01	#14	626	S1	S1
MB1A I/C Core	2 - 2-3/8\"/>						

If not specified at time of order, the default will be 2 3/4" backset, 15 Lever, 626 Finish, S1 Strike MB1-093K drop-in door adaptor kit for Best 9K hole prep is available and sold separately.

The following items are purchased separately:

- S1-7/8-finish 7/8" flat lip strike (605, 606, 612, 613, 630)
- MB1-3/4-finish 3/4" throw fire door deadlatch (605, 606, 612, 613, 630)
- MB1-L4-3-3/4 Extension link for 3-3/4" backset latch
- MB1-L5-5 Extension link for 5" backset latch

H1 function requires special core and Hotel throw member 25647 7-pin, 25648 6-pin.

MB1A Series Lever Locks





FUNCTIONS

	Description	Outside Lever		Inside Lever	
		Latched operated by	Locked by	Unlocked by	Locked by
Single Keyed Functions					
01 - Entrance AB F109 	<ul style="list-style-type: none"> • Rotating the inside lever, OR • Rotating the outside lever - only when the inside push button is out, OR • Turning the key in the outside lever 	<ul style="list-style-type: none"> • Pushing the inside button, OR • Pushing and turning the inside button. Turning the button keeps the outside lever locked until the button is turned back. 	<ul style="list-style-type: none"> • Turning the key in the outside lever, (only when the button is not turned) OR • Rotating the inside lever, (only when the button is not turned), OR • Closing the door (only when the button is not turned) 	Cannot be locked	Always unlocked
03 - Classroom R F84 	<ul style="list-style-type: none"> • Rotating the inside lever, OR • Turning the key in the outside lever OR • Rotating the outside lever when not locked by key 	Turning the key in the outside lever	Turning the key in the outside lever	Cannot be locked	Always unlocked
05 - Storeroom D F86 	<ul style="list-style-type: none"> • Turning the key in the outside lever, OR • Rotating the inside lever 	Always locked	Cannot be unlocked	Cannot be locked	Always unlocked
H1 - Hotel Guest Room H1 F93 	<ul style="list-style-type: none"> • Rotating the inside lever, OR • Turning the key in the outside lever only when the inside push button is out, OR • Removing the core with a control key and using a special emergency key 	Always locked	Key block feature is released by: <ul style="list-style-type: none"> • Rotating the inside lever, OR • Closing the door 	Cannot be locked	Always unlocked
PUSHING THE INSIDE BUTTON PROJECTS AN OCCUPIED INDICATOR IN THE OUTSIDE LEVER AND BLOCKS ALL OPERATING KEYS					
T - Dormitory T F90 	<ul style="list-style-type: none"> • Rotating the inside lever, OR • Rotating the outside lever when not locked by key or push button 	<ul style="list-style-type: none"> • Turning the key in the outside lever, OR • Pushing the button on the inside lever 	<ul style="list-style-type: none"> • Turning the key in the outside lever, OR • Rotating the inside lever (only when locked by push button), OR • Closing the door (only when locked by push button) 	Cannot be locked	Always unlocked
Double Keyed* Functions					
02 - Storeroom* G F91 	<ul style="list-style-type: none"> • Rotating the outside lever, when not locked by key, OR • Rotating the inside lever when not locked by key 	<ul style="list-style-type: none"> • Turning the key in the inside lever, OR • Turning the key in the outside lever 	<ul style="list-style-type: none"> • Turning the key in the inside lever, OR • Turning the key in the outside lever 	<ul style="list-style-type: none"> • Turning the key in the inside lever, OR • Turning the key in the outside lever 	<ul style="list-style-type: none"> • Turning the key in the inside lever, OR • Turning the key in the outside lever
04 - Communicating* S F80 	<ul style="list-style-type: none"> • Turning the key in the inside lever, OR • Turning the key in the outside lever, OR • Rotating the inside or outside lever (if unlocked) 	Turning the key in the outside lever	Turning the key in the outside lever	Turning the key in the inside lever	Turning the key in the inside lever
TURNING THE KEY IN EITHER LEVER, LOCKS OR UNLOCKS ITS OWN LEVER INDEPENDENTLY.					
06 - Corridor C F88 	<ul style="list-style-type: none"> • Rotating the inside lever, OR • Rotating the outside lever when not locked by key, OR • Turning the key in the outside lever 	Turning the key in the inside lever	Turning the key in the inside lever	Cannot be locked	Always unlocked
09 - Institutional* W F87 	<ul style="list-style-type: none"> • Turning the key in the inside lever OR • Turning the key in the outside lever 	Always locked	Cannot be unlocked	Always locked	Cannot be unlocked

*Attention: Locksets that secure both sides of the door are controlled by building codes and the Life Safety Codes. In an emergency situation, failure to quickly unlock the inside lever could be hazardous or even fatal.

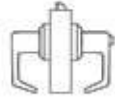
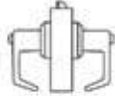
FUNCTIONS

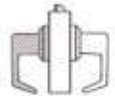
MB1A Series Lever Locks

	Description	Outside Lever		Inside Lever	
		Latch operated by	Locked by	Unlocked by	Locked by
Double Keyed* Functions (Continued)					
IN - Intruder  IN	<ul style="list-style-type: none"> Rotating inside lever, OR Rotating outside lever only when not locked by inside or outside key 	<ul style="list-style-type: none"> Turning key in the inside lever, OR Turning the key in the outside lever 	<ul style="list-style-type: none"> Turning key in the inside lever, OR Turning the key in the outside lever 	Cannot be locked	Always unlocked
Keyless Functions					
10 - Patio  P F77	<ul style="list-style-type: none"> Rotating the inside lever, OR Rotating the outside lever only when the inside push button is out 	Pushing the inside button	<ul style="list-style-type: none"> Rotating the inside lever, OR Closing the door 	Cannot be locked	Always unlocked
14 - Time Out  TO	<ul style="list-style-type: none"> Rotating the inside lever, OR Rotating the outside lever only when the inside push button is out 	Pushing and holding the inside button	Releasing the inside button	Cannot be locked	Always unlocked
20 - Privacy  L F76	<ul style="list-style-type: none"> Rotating the inside lever, OR Rotating the outside lever only when the inside push button is out 	Pushing the inside button	<ul style="list-style-type: none"> Rotating the outside slotted button, OR Rotating the inside lever, OR Closing the door 	Cannot be locked	Always unlocked
30 - Passage  N F75	<ul style="list-style-type: none"> Rotating the inside lever, OR Rotating the outside lever 	Cannot be locked	Always unlocked	Cannot be locked	Always unlocked
40 - Single Dummy Trim  1 DT	This is a single, surface-mounted lever for an inactive door or a non-latching door.				
50 - Exit  NX F89	Rotating the inside lever	Always locked	Always locked	Cannot be locked	Always unlocked
60 - Exit  Y	Rotating the inside lever			Cannot be locked	Always unlocked

Out of an abundance of caution, MBS has elected to place the Proposition 65 warning on all products shipped to California.





WARNING: These products can expose you to chemicals including chromium, which is known to the State of California to cause cancer and birth defects or other reproductive harm. For more information go to www.P65Warnings.ca.gov.

*Attention: Locksets that secure both sides of the door are controlled by building codes and the Life Safety Codes. In an emergency situation, failure to quickly unlock the inside lever could be hazardous or even fatal.

MB1A Series Lever locks

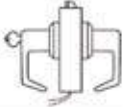
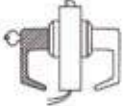
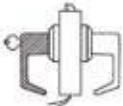
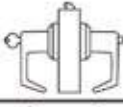
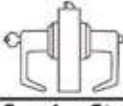
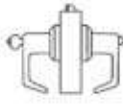
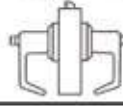
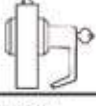
FUNCTIONS

	Description	Outside Lever		Inside Lever	
		Latched by	Locked by	Unlocked by	Locked by
Electromechanical Functions					
**EL - Electrically Locked 	<ul style="list-style-type: none"> Rotating the inside lever, OR Rotating the outside lever only when the power is off, OR Turning the key in the outside lever 	<ul style="list-style-type: none"> Applying 24 Volts DC Outside lever remains locked only while power is on 	Switching off 24 Volts DC	Cannot be locked	Always unlocked
**EU - Electrically Unlocked 	<ul style="list-style-type: none"> Rotating the inside lever, OR Rotating the outside lever only when power is on, OR Turning the key in the outside lever 	Switching off 24 Volts DC	<ul style="list-style-type: none"> Applying 24 Volts DC Outside lever remains unlocked only while power is on 	Cannot be locked	Always unlocked
**RX - Storeroom Lock 	<ul style="list-style-type: none"> Rotating the inside lever, OR Turning the key in the outside lever 	Always locked	Cannot be unlocked	Cannot be locked	Always unlocked
**A microswitch attached to the chassis is activated when the inside lever is rotated. Switch signals use of the inside lever to security systems allowing non-disruptive egress.					
Special Functions					
00 - Office B F82 	<ul style="list-style-type: none"> Rotating the inside lever, OR Rotating the outside lever only when inside push button is out, OR Turning the key in the outside lever 	Pushing the inside button	<ul style="list-style-type: none"> Turning the key in the outside lever, OR Rotating the inside lever 	Cannot be locked	Always unlocked
07 - Dormitory or Storeroom A F81 	<ul style="list-style-type: none"> Rotating the inside lever, OR Rotating the outside lever only when inside turn button is unlocked position, OR Turning the key in the outside lever 	Turning the inside button	Turning the inside button	Cannot be locked	Always unlocked
15 - Service Station E F92 	<ul style="list-style-type: none"> Rotating the inside lever, OR Rotating the outside lever - only when the inside push button is out, OR Turning the key in the outside lever 	<ul style="list-style-type: none"> Pushing the inside button, OR Pushing and turning the inside button. Turning the button keeps the outside lever locked until the button is turned back. 	<ul style="list-style-type: none"> Turning the key in the outside lever, Rotating the inside lever, Closing the door - only when the button is not turned, Turning back the slotted button 	Cannot be locked	Always unlocked
21 - Hospital Privacy 	<ul style="list-style-type: none"> Rotating the inside lever, OR Rotating the outside lever only when inside push button is out 	Pushing the inside button	<ul style="list-style-type: none"> Turning the turn button in the outside lever, OR Rotating the inside lever, OR Closing the door. 	Cannot be locked	Always unlocked
63 - Exit* 	Turning the key in the inside lever, OR rotating the inside lever when not locked by key			Turning the key in the inside lever	Turning the key in the inside lever
63 - YD* 	Turning the key in the inside lever			Always fixed	Cannot be unlocked

*Attention: Locksets that secure both sides of the door are controlled by building codes and the Life Safety Codes. In an emergency situation, failure to quickly unlock the inside lever could be hazardous or even fatal.



Cylindrical Locks with Clutching Mechanism

- Vandal resistant clutching mechanism in outside trim assembly
- Ideally suited for hospitals, schools, universities, factories, offices and other areas requiring more security
- Top quality, added security
- Wrought rose or escutcheon made of brass
- Available with small or large format interchangeable core or standard cylinder
- 3 Solid-touch grip levers
- Available in 6 attractive BHMA finishes – 605, 606, 612, 613, 625, 626
- Levers ADA compliant
- UL listed 3-hour fire rating
- ANSI Grade 1
- Seven (7) year manufacturer's limited warranty

Available Functions:

- 01 Entrance
- 03 Classroom
- 05 Storeroom
- 09 Institutional
- 20 Privacy
- 00 Office, B function
- IN Intruder
- T Dormitory
- EL Electrically Locked
- EU Electrically Unlocked
- RX Request to Exit

How To Order Clutching	Model Series	Backset	Function Code	Lever Handle	Finish	Strike	Options
	MB1CA	3	01	#14	626	S1	
MB1CA I/C Core clutching	2 - 2-3/8" 3 - 3-3/4"	See Function List On Right	#14 #15 #16	605 606 612 613 625 626	S1 - ANSI strike S2 - T Strike	AL - Abrasive Lever LL - Lead Lined NOTE: Specify Inside (I), Outside (O), or Both (B) for AL option	

If not specified at time of order, the default will be 2 3/4" backset, 15 Lever, 626 Finish, S1 Strike
MB1-093K drop-in door adaptor kit for Best 9K hole prep is available and sold separately.

The following items are purchased separately:

- S1-7/8-finish 7/8" flat lip strike (605, 606, 612, 613, 630)
- MB1-3/4-finish 3/4" throw fire door deadlatch (605, 606, 612, 613, 630)
- MB1-L4-3-3/4 Extension link for 3-3/4" backset latch
- MB1-L5-5 Extension link for 5" backset latch

How To Order EL/EU RX	Model Series	Backset	Function Code	Lever Handle	Finish	Strike	Power	RX	Options
	MB1A	3	EU	15	626	S1	24v	RX	
MB1A I/C Core MB1CA	2 - 2-3/8" 3 - 3-3/4"	EL EU	#14 #15 #16	605 606 612 613 625 626	S1 - ANSI strike S2 - T Strike	24v (standard) 12v (optional)	RX (standard)	AL - Abrasive Lever LL - Lead Lined NOTE: Specify Inside (I), Outside (O), or Both (B) for AL option	

How To Order 05 RX	Model Series	Backset	Function Code	Lever Handle	Finish	Strike	RX	Options
	MB1A	3	05	15	626	S1	RX	
MB1A I/C Core MB1CA	2 - 2-3/8" 3 - 3-3/4"	05	#14 #15 #16	605 606 612 613 625 626	S1 - ANSI strike S2 - T Strike	RX (standard)	AL - Abrasive Lever LL - Lead Lined NOTE: Specify Inside (I), Outside (O), or Both (B) for AL option	



Marshall Best Security Corporation

www.marshallbestsecurity.com
13097 Parkside Drive, Suite B
Fishers, IN 46038
317-806-1180